



INSTALLATION INSTRUCTIONS

Accessory ALL-SEASON FLOOR MATS P/N 08P13-TX4-200	Application 2015 RDX	Publications No. BII 51207
		Issue Date MARCH 2014

PARTS LIST

Driver's all-season floor mat

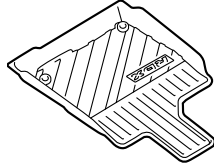

Passenger's all-season floor mat



Rear all-season floor mat

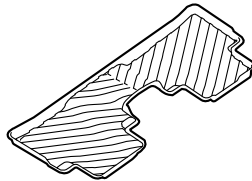
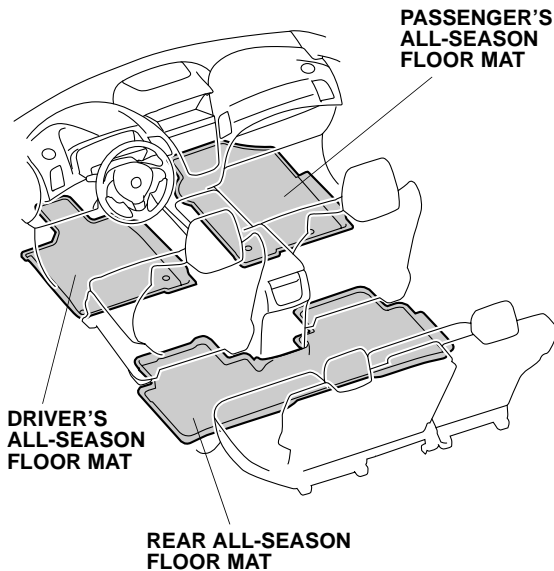

Illustration of the All-Season Floor Mats in the Vehicle



INSTALLATION

NOTE:

- Remove the standard floor mats before installing the all-season floor mats.
- If you remove the all-season floor mat, make sure you reanchor it when you put it back in your vehicle.
- If you replace the all-season floor mats, use factory all-season floor mats that are designed to be used with the anchors.
- If you use a non-factory mat in the driver's foot well, make sure it fits properly and that it can be used with the anchor.
- Do not put any additional mats on top of the anchored mat. An additional mat may slide forward and possibly interfere with the pedals.
- Identify each mat by the marks on the back of each mat: the mat marked "R" or "Passenger's side" goes on the right side of the vehicle; the mat marked "L" or "Driver's side" goes on the left side.

1. Install the rings in the driver's all-season floor mat over the anchors. Turn the knob on each anchor 90° to secure the driver's all-season floor mat.

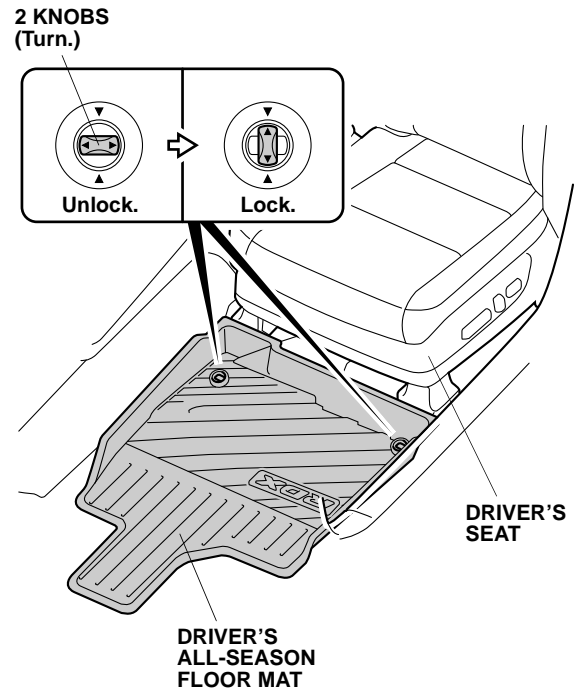

2. Install the rings in the passenger's all-season floor mat over the anchors. Turn the knob on each anchor 90° to secure the passenger's all-season floor mat.

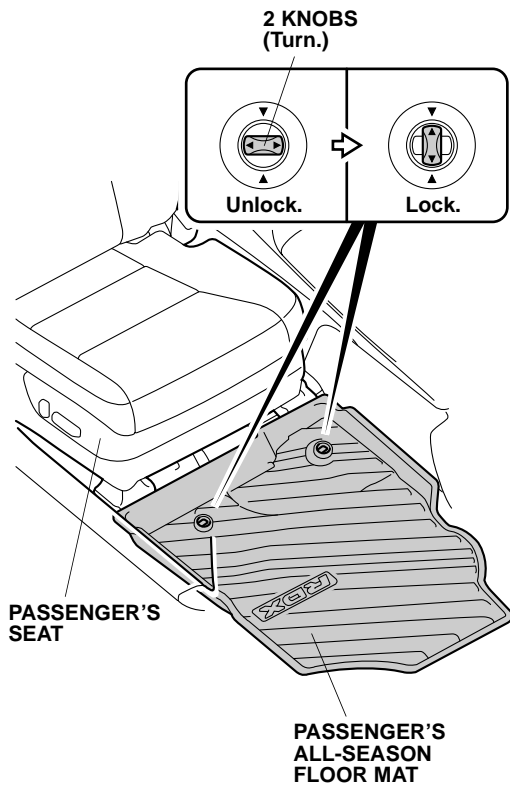

3. Position the rear all-season floor mat as shown.

